

CIRUS
advanced heater technology

ROPEX
INDUSTRIE - ELEKTRONIK

Heating elements for sealing plastic films

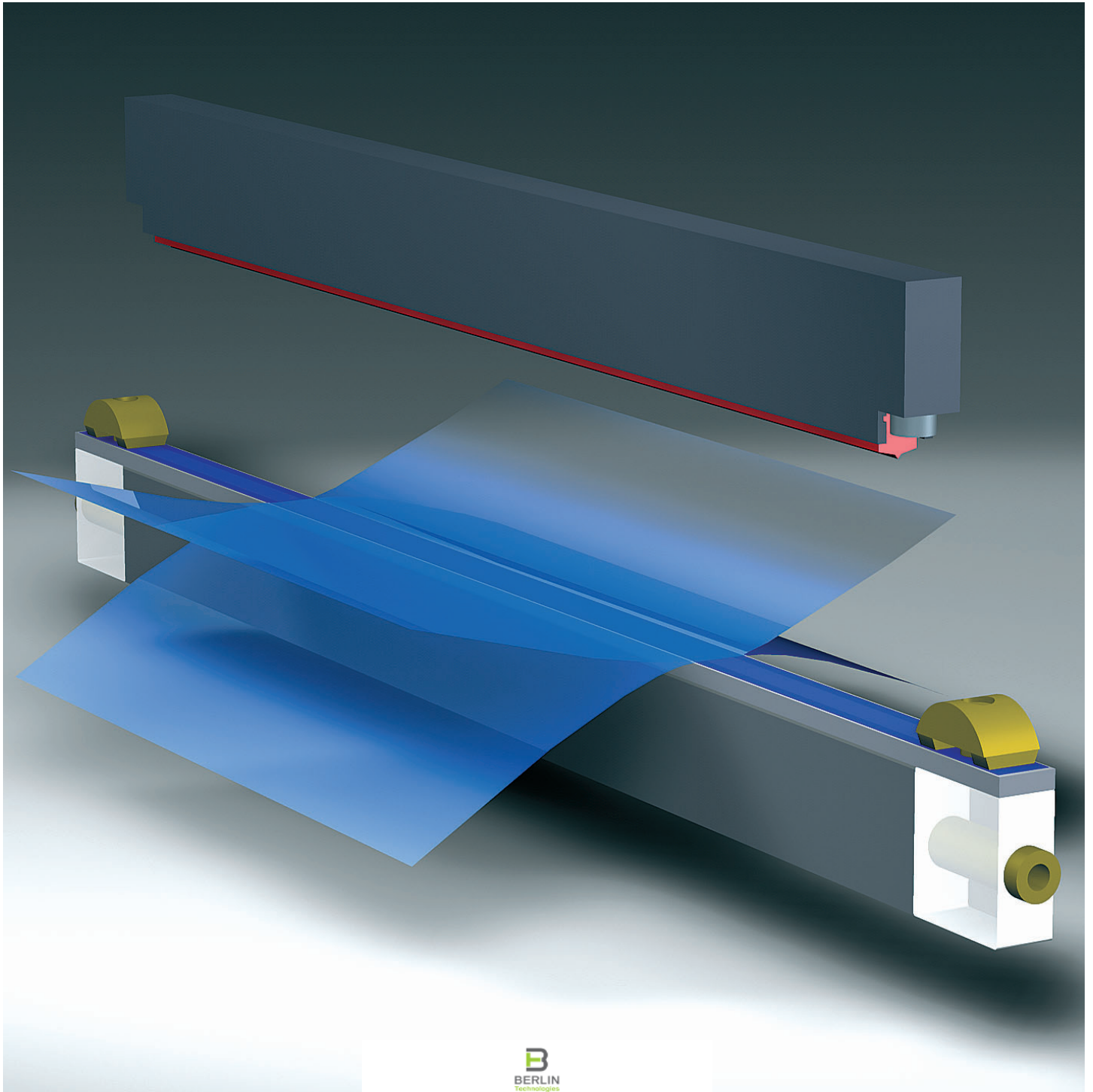

B
BERLIN
Technologies

ברלין טכנולוגיות בע"מ
שדרות גן רוהה 13, יבנה, 8122214
<http://www.berlintech.co.il/>
mail@berlintech.co.il
טלפון: 073-7597171
פקס: 08-6638120

ULTRA-PULSE: more than heat

Contents

1. General	3
2. Structure of CIRUS heating elements	4
3. Ultra-pulse and long-pulse technology	5
3.1 Ultra-pulse technology (UPT)	5
3.2 Long-pulse technology (LPT)	6
3.3 Sensor monitoring	7
4. System configuration	8
5. System characteristics	9
6. Design variants of ultra-pulse heatsealing tools	12
6.1 UPT standard heatsealing bars	12
6.2 UPT “Flex“ tools	15
6.3 Customized UPT heatsealing tools	16
7. Opposing UPT heatsealing tools: silicone profiles and silicone retainers	17
8. Film release after the heatsealing process	18
9. Electrical components	20
10. Temperature controllers	21

1. General

CIRUS (Cermet Integrated Resistive Ultrafast Sensorless heaters) heatsealing tools are the outcome of an ongoing development process at ROPEX GmbH lasting many years. Extensive experience embracing more than 25 years as a leading supplier of systems to control the temperature of heatsealing bands laid the foundation for this new technology. (Patent Nos. 197 37 471 and 198 15 763)

CIRUS heatsealing tools have succeeded in overcoming the familiar drawbacks of conventional film sealing tools, namely in particular:

- The long temperature rise and cooling times
- The complex mechanical designs that are necessary:
 - a) To compensate thermal expansion
 - b) To ensure reliable current transfers
 - c) To avoid local overheating (coppering)
- The need to use anti-stick coverings (teflon)
- The restriction to specific formats
- The short service life
- The high costs of maintenance
- etc.

CIRUS heating elements

- Are extremely dynamic
- Have no moving parts
- Dispense with anti-stick coverings
- Are format-neutral
- Require no maintenance
- Are durable

In combination with specially tailored control loop components, such as a temperature controller (UPT/LPT-640), impulse-transformers (ITR-x), silicone profiles, a cooler etc., they provide ROPEX GmbH customers with an optimized overall system that guarantees reliable operation, thus saving both time and money.

**Benefit from integrated,
ready-to-operate solutions!**

2. Structure of CIRUS heating elements

Several layers of glass-ceramic materials are applied to a plane, stainless steel substrate as insulation. Various layers of glass-metal materials are then applied in a defined geometry to act as a heating layer and for measuring the temperature. The final coating is a protective cover. Each time a new layer is applied, all the layers are sintered at +850° C.

This results in a material-formed multilayer bond with properties previously unheard of in film sealing technology:

- The heating layer, which is only a few μm thick, has a very low thermal mass and capacity.
- The steel holder and the glass insulation have a very low lateral thermal conductivity.
- The gap between the hot heating layer and the film is only a few μm .
- Heating in impulse mode causes no change in the length of the heating layer.
- The almost unlimited choice of two-dimensional geometries for the heat-sealing tools make them exceptionally versatile (e.g. shaped tools).

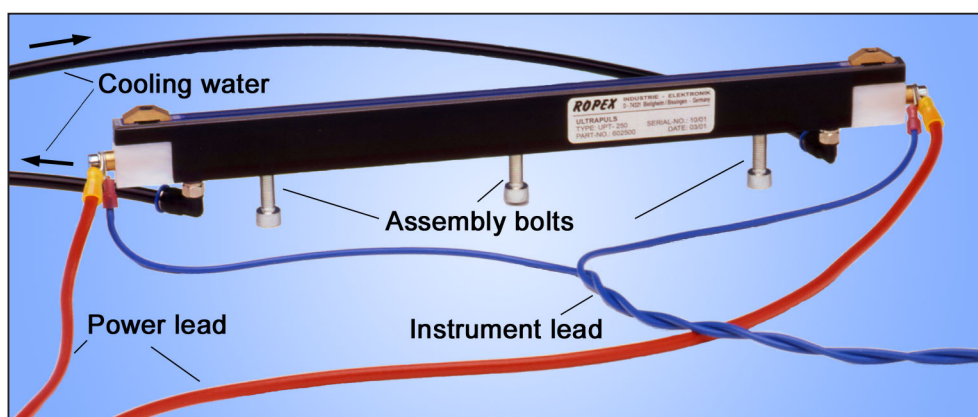
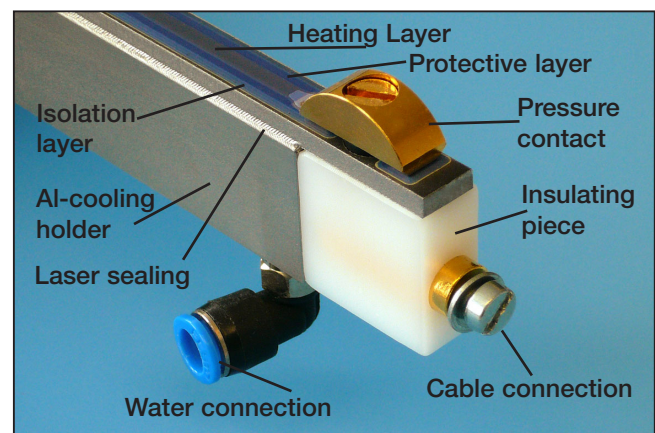
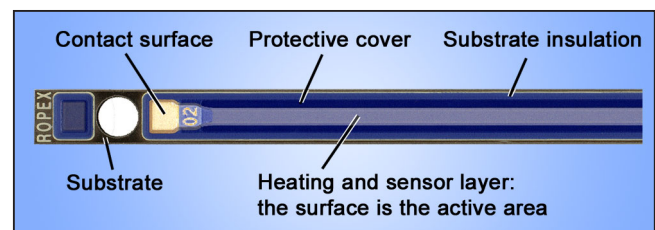
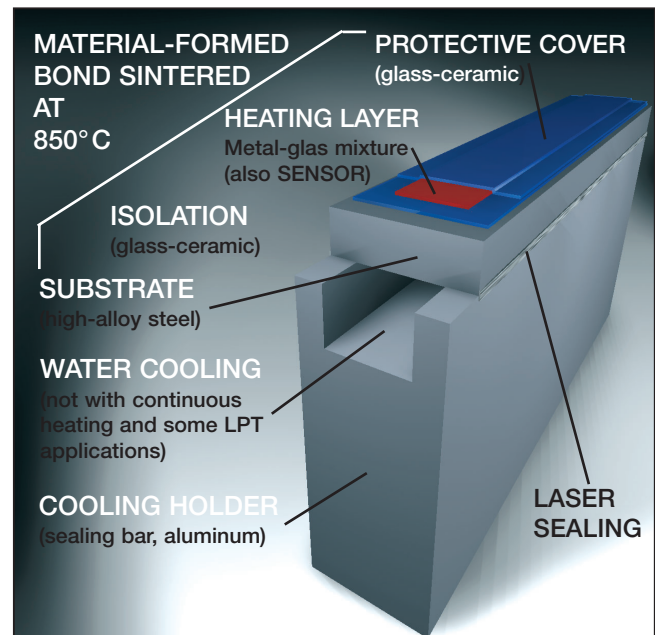

3. Ultra-pulse and long-pulse technology

Two different technologies are used for CIRUS heatsealing tools, depending on the tool design and mode of operation:

Ultra-Pulse-Technology (UPT) or Long-Pulse-Technology (LPT)

3.1 Ultra-pulse technology (UPT)

This technology generates heat impulses in the region of a few hundred milliseconds.

In addition to the UPT heatsealing tool, the system essentially consists of a UPT controller and a water cooler for the tool. The tool always operates in impulse mode. It is characterized by extremely short slope times for heating and cooling - typically around $6000^{\circ}\text{K/sec.}$ for heating and $3000^{\circ}\text{K/sec.}$ at the start of the cooling phase (e-function).



A special UPT controller ensures precise and highly dynamic temperature control. It is supported by the low mass of the heating layer (only a few μm thick), which simultaneously acts as the sensor layer for measuring the temperature.

The working surface for the sealing process is restricted to the area above the heating layer (-> "Structure").

ROPEX GmbH offers a range of linear UPT sealing bars for use in standard applications (-> section 8).

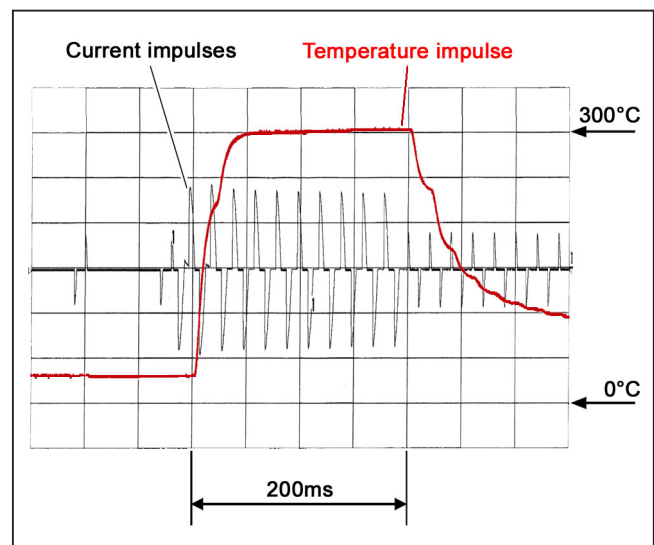

As well as controlling the temperature, this controller generates heatsealing and cooling times, monitors the system for possible faults, and displays diagnostic results.

- Two different design variants are available:
- With VFD display for mounting on a front panel,
 - With PROFIBUS control for mounting on a top hat rail (-> section 10)

3.2 Long-pulse technology (LPT)

Long-pulse technology generates heat impulses from a few seconds right up to continuous heating.

The tool has to be cooled in heat impulse mode (e.g. with air or water), in contrast - by definition - with continuous heating.

The heating element consists of a heating layer and a separate sensor layer for measuring the temperature.

The two layers are formed in a common manufacturing process. The freely designable heating layer geometry enables temperature profiles to be defined and created. Furthermore, it is possible to compensate edge losses and heat sinks. The same applies to the sensor layer, which can be partially deactivated to permit the temperature to be measured only at points relevant to the process (Fig. b.).

The sensor layer can be applied either on the same plane as the heating layer or on the reverse of the substrate. The active working surface (heatsealing surface) can be optionally on the same plane as the heating layer or perpendicular to it.

An LPT controller specially tailored to the system takes care of temperature control.

Refer to section 10 for details of the available LPT controller design variants and their respective properties.

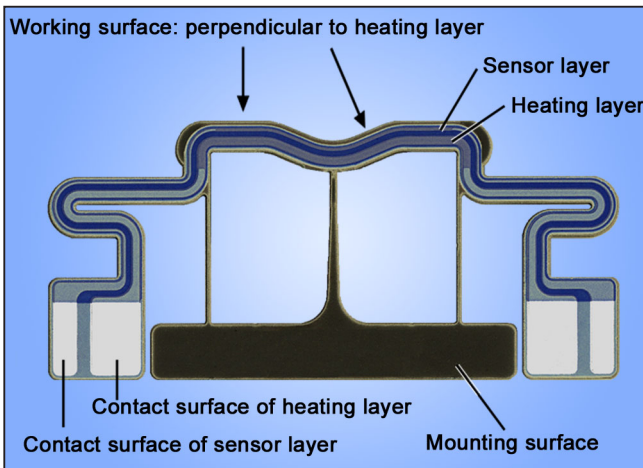

a.) Example of an LPT heatsealing tool with heating and sensor layers on one plane

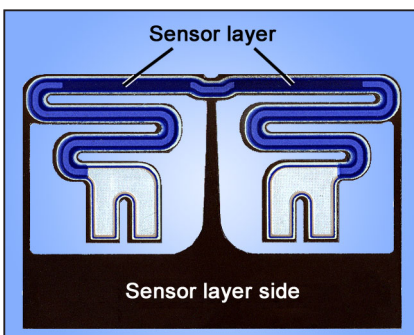

Front

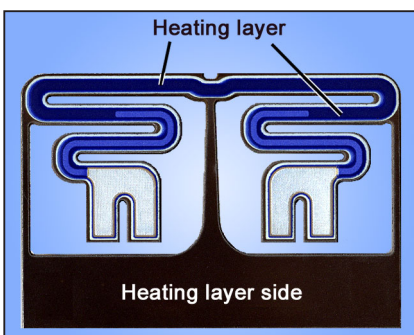

b.) Example of an LPT heatsealing tool with a partial sensor layer on the reverse

Reverse



In addition to sealing film, the unit also efficiently accomplishes other joining tasks, such as soldering or bonding.

LPT tools are customized solutions.

3.3 Sensor monitoring

The technical design of CIRUS heating elements allows additional functional layers to be integrated in the heater structure, such as a sensor layer for autonomous temperature detection.

The sensor layer, which is applied over the heating layer, is completely isolated from the heating circuit and separated from it by an insulation layer. It is itself protected by a superimposed glass ceramic cover.

Thanks to the optimal arrangement of the sensor layer in the overall layer structure and

the excellent heat coupling, both to the heating layer and to the product (film), this sensor supplies an instantaneous signal that represents the heatsealing process and can be used for process monitoring (e.g. validation).

A monitoring device (RMTS) completely separate from the control loop is connected to the sensor layer. It compares various parameters with the programmable limit values.

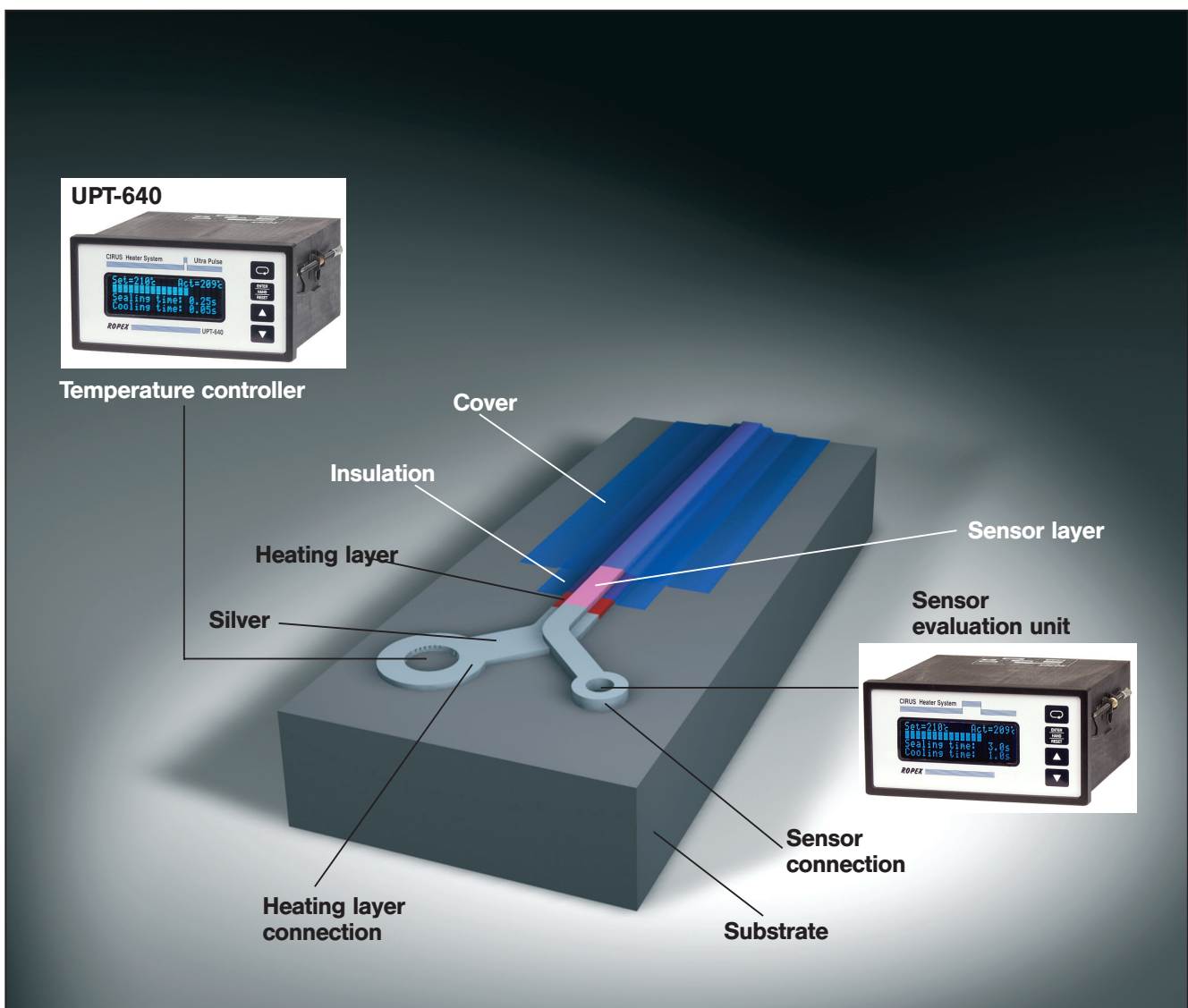

4. System configuration

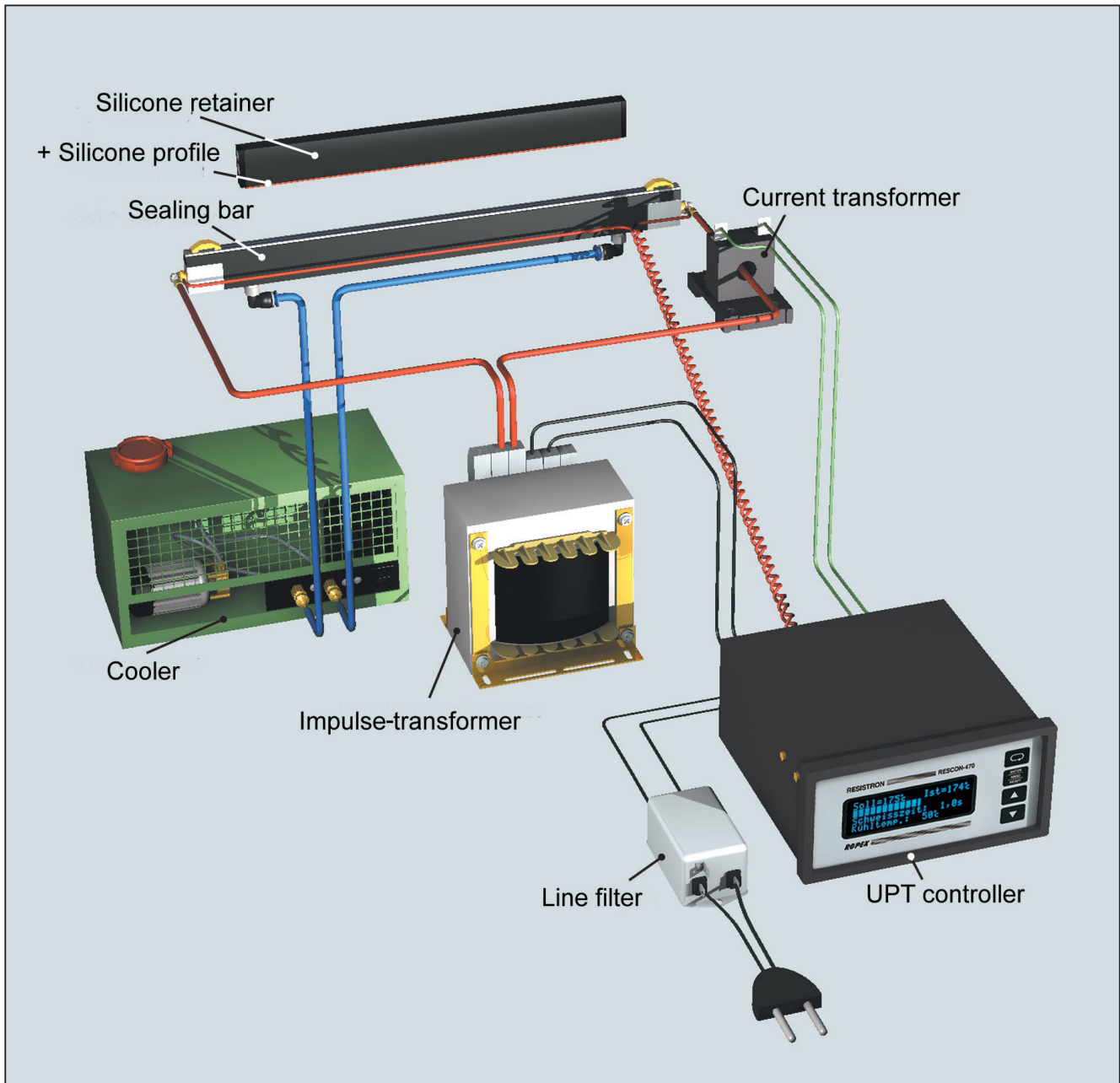

CIRUS heating elements, and in particular UPT heating elements, are high-performance systems which operate efficiently and reliably providing all the components in the control loop are optimally tuned to one another - and to the task at hand. Exact compliance with the installation and wiring instructions is essential. The system has been evolved and optimized by ROPEX GmbH in an intensive development process.

Users who follow with our technical recommendations will profit from the unique functionality of this technology, which reduces the customer's effort for installation, commissioning and maintenance to a minimum.

5. System characteristics

● Optimized thermal dynamics

The extremely fast temperature rise with typical slope steepnesses of 6000 °K/second, followed by rapid cooling after the heating phase, is the outstanding feature of CIRUS ULTRA-PULSE heatsealing tools.

The optimized thermal dynamics are the result of the physical properties and the structure of the layers, combined with the fact that the heating layers are only a few μm away from the sealing surface. Moreover, the heat for the sealing process no longer has to penetrate any insulating, anti-stick layers.

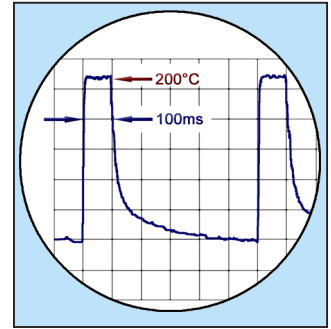

ULTRA-PULSE combines very short cycle times with previously unattainable seal strength after the tool is opened plus a heatseal that creates an excellent visual impression.

● Cold tools

The geometrically exact delimitation of the heated surface - in conjunction with the cooled holder - results in "cold tools" in impulse mode, in other words the sealing surface is only hot for a few hundred milliseconds during the heatsealing process. A few tenths of a second later, it has already cooled down.

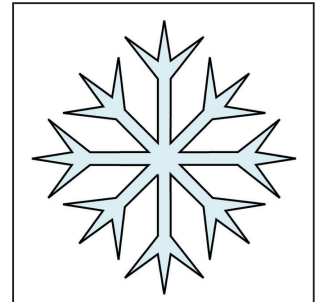

ULTRA-PULSE heatsealing tools radiate zero heat into the atmosphere!

● Simple, reliable design requiring practically no maintenance

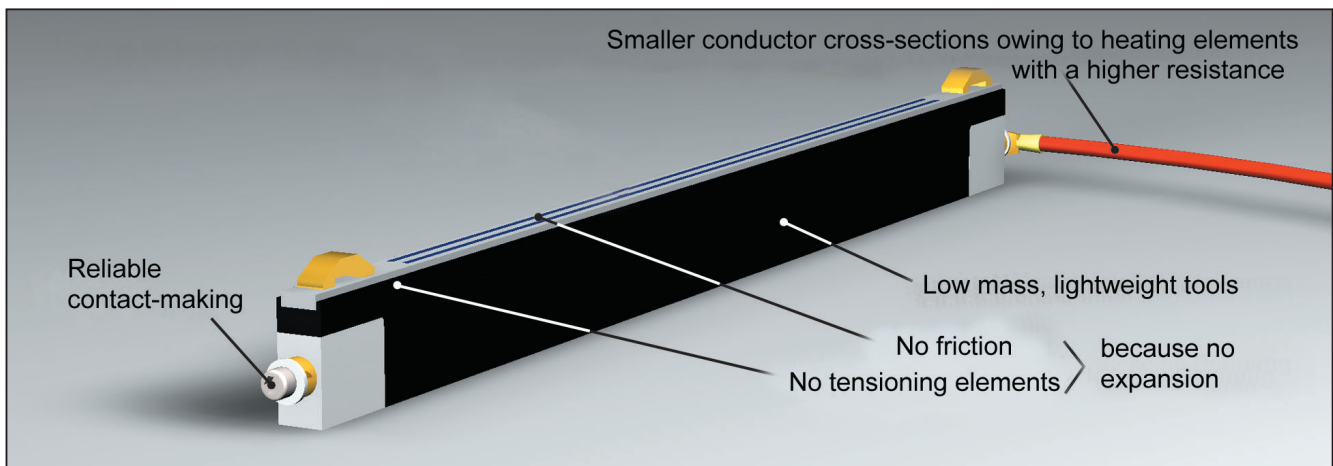

- **Long service life**

ULTRA-PULSE heating elements also endure a very large number of cycles under extreme, alternating thermal loads (impulse mode).

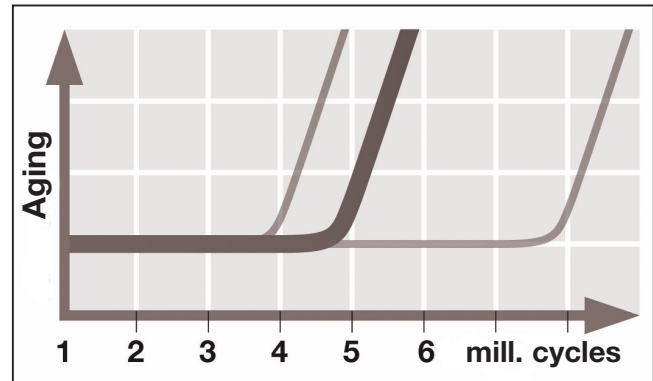

** The actual service life can vary considerably according to the operating conditions.*

- **Format-neutral**

ULTRA-PULSE heating elements allow narrow webs of film to be processed with long sealing bars without any problems, because there is no temperature rise in the unloaded zones.

Partial thermal loading of the UPT heatsealing tool does not impair the heatseal quality in any way.

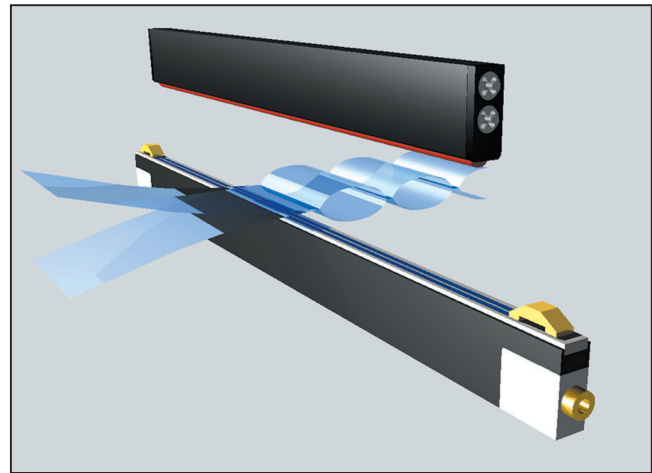

- **An anti-stick cover can be dispensed with in many applications**

The fact that many film types no longer require an anti-stick cover means that ULTRA-PULSE heatsealing tools are extremely durable and maintenance-free. Since the strength of the seal is restored almost instantly following the sealing pro-

cess, the film can either be simply pulled away from the heatsealing tool or released from it with the help of a short impulse (-> "Release impulse").

Since ULTRA-PULSE heating elements can also be used without a wearing anti-stick cover, maintenance is reduced to a minimum.

- **Minimal manufacturing tolerances**

The manufacturing process has matured over many years, leading to excellent reproducibility of the electrical and geometry data.

● **Temperature distribution on CIRUS heating elements**

In the majority of applications a homogeneous temperature distribution is favorable on the surface formed by the heating layer.

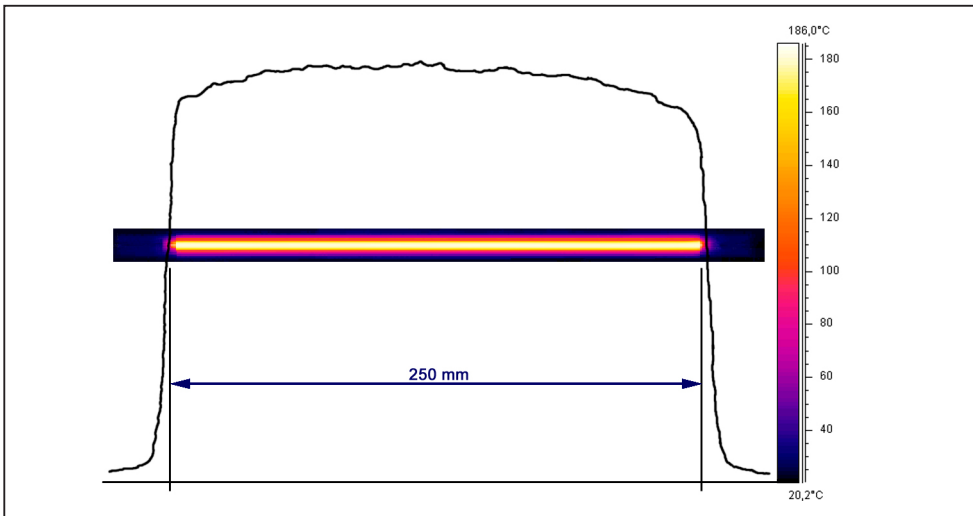

IR thermal images clearly reveal the extremely stable temperature in the longitudinal direction of a standard UPT sealing bar. The "sharpness" of the thermal image towards the cold outer zones is also easily recognizable.

By modifying the layer architecture, it is possible to obtain a specific temperature profile in individual cases, both in the longitudinal direction and perpendicular to the heating layer, which can also include heating layer interruptions with cold sections.

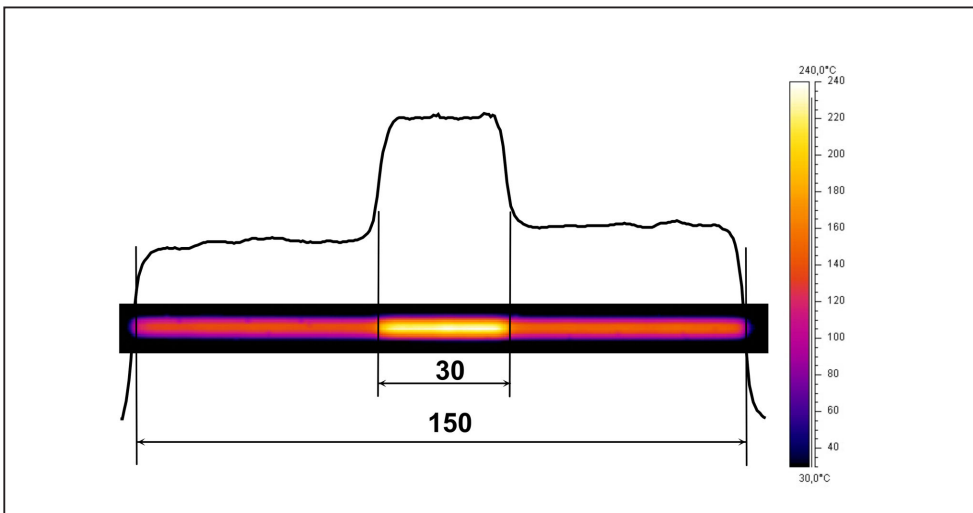

Temperature profile parallel to the heating layer: temperature increase in the middle.

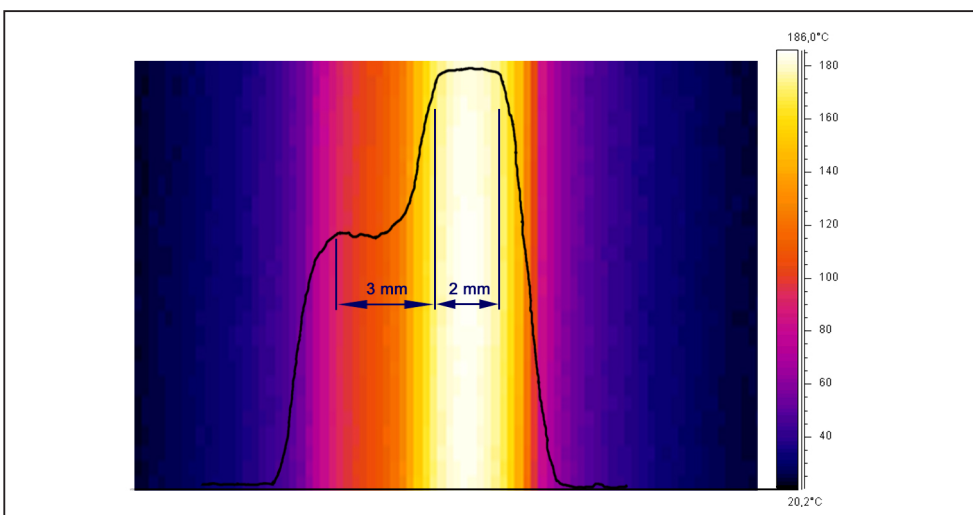

Temperature profile perpendicular to the heating layer and asymmetrical to the longitudinal axis.

6. Design variants of ULTRA-PULSE heatsealing tools

6.1 ULTRA-PULSE standard heatsealing bars

ROPEX offers a standard range of linear ULTRA-PULSE heatsealing tools from stock in lengths from 200 mm to 1000 mm and with heating layer widths from 1.6 to 6 mm.

These bars, which are ready to install and connect, are designed with electrical and cooling water connections as well as tapped holes for mechanical assembly.

(Refer to our "Standard heatsealing bars" leaflet for technical data).

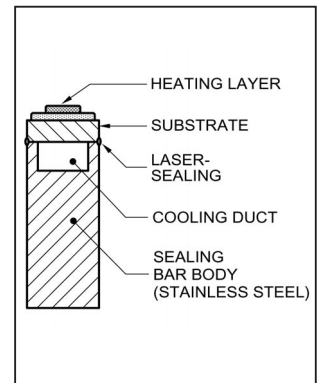

Standard heatsealing bars



Lengths from 200 to 450 mm

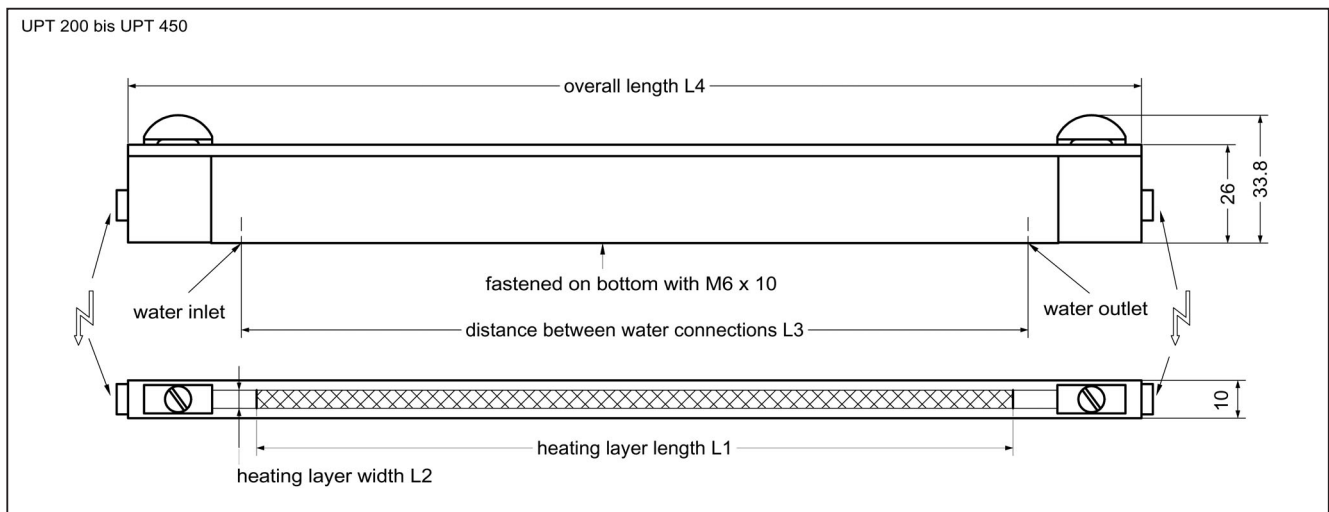

Heating layer length L1/mm	Heating layer width L2/mm	Distance between water connections L3/mm	Overall length L4/mm	Name
	1.6			UPT-200/1.6
200	2.8	208	268	UPT-200/2.8
	4.8			UPT-200/4.8
	1.6			UPT-250/1.6
250	2.8	258	318	UPT-250/2.8
	4.8			UPT-250/4.8
	1.6			UPT-300/1.6
300	2.8	308	368	UPT-300/2.8
	4.8			UPT-300/4.8
	1.6			UPT-350/1.6
350	2.8	358	418	UPT-350/2.8
	4.8			UPT-350/4.8
	1.6			UPT-400/1.6
400	2.8	408	468	UPT-400/2.8
	4.8			UPT-400/4.8
	1.6			UPT-450/1.6
450	2.8	458	518	UPT-450/2.8
	4.8			UPT-450/4.8

Lengths from 500 to 1000 mm

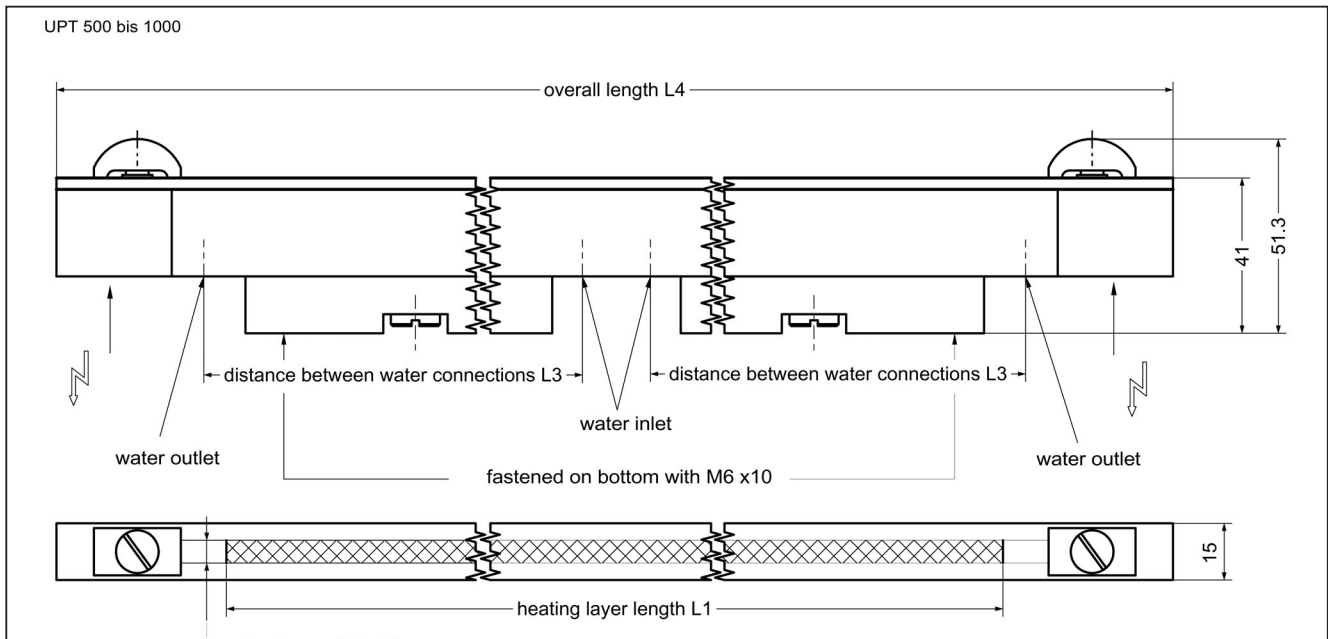

Heating layer length L1/mm	Heating layer width L2/mm	Distance between water connections L3/mm	Overall length L4/mm	Name
	2.8			UPT-500/2.8
500	4.8	249	590	UPT-500/4.8
	6.0			UPT-500/6.0
	2.8			UPT-600/2.8
600	4.8	299	690	UPT-600/4.8
	6.0			UPT-600/6.0
	2.8			UPT-700/2.8
700	4.8	349	790	UPT-700/4.8
	6.0			UPT-700/6.0
	2.8			UPT-800/2.8
800	4.8	399	890	UPT-800/4.8
	6.0			UPT-800/6.0
	2.8			UPT-900/2.8
900	4.8	449	990	UPT-900/4.8
	6.0			UPT-900/6,0
	2.8			UPT-1000/2.8
1000	4.8	499	1090	UPT-1000/4.8
	6.0			UPT-1000/6.0

6.2 ULTRA-PULSE "Flex" tools

If very thick film types or layers need to be sealed, it is an advantage to heat both sides of the film material in order to reduce the heatsealing time and prevent deformation of the seal.

If the number of film layers varies within one application, for instance if both a longitudinal seam (3 layers) and side folds (4 layers) have to be sealed, the heating element must be capable of adapting to this uneven surface to ensure that the seal is tight.

This is not possible with two rigid heatsealing bars that act counter to one another.

"FLEX" tools have a thin heating element vulcanized with an elastic silicone substrate, which also acts as the cooling duct. This assures the necessary elasticity to guarantee bilateral heating as well as sufficiently uniform pressure on both sides of the film. It

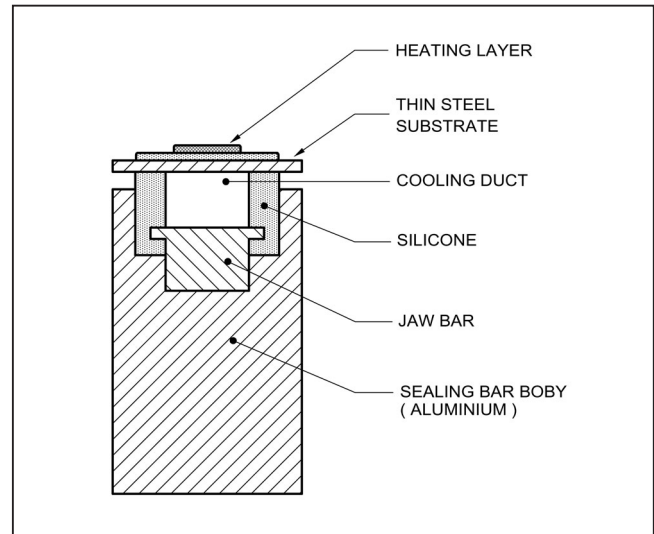

also compensates any errors in the parallelism of the heatsealing bar closing mechanism.

The contacts on the ends of the FLEX bars are laterally offset from the longitudinal axis to enable two bars to be matched.

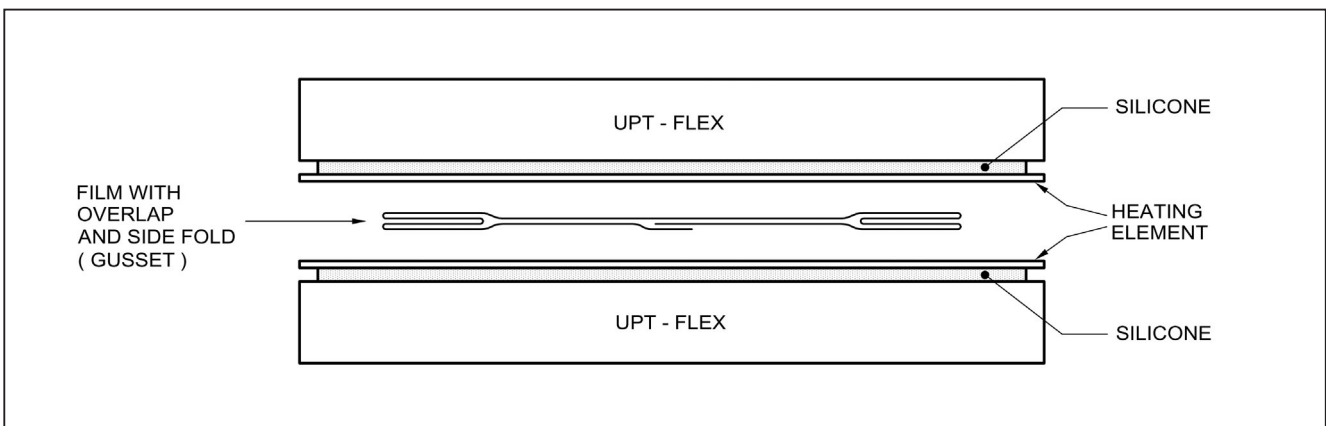

If the heating elements of a FLEX heatsealing tool are damaged or worn, they can be individually replaced without having to exchange the cooling body.

Refer to our "UPT-FLEX tools" leaflet for technical data.

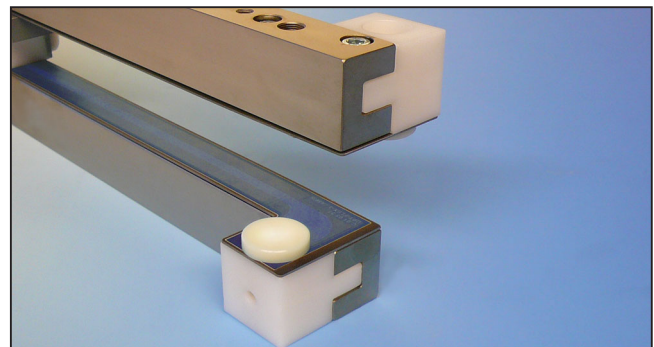

6.3 Customized ULTRA-PULSE heatsealing tools

The flexibility that can be achieved by modifying the heating layer geometry and temperature distribution and the numerous mechanical design variants for heatsealing tools in CIRUS technology are an immense benefit if the customer is seeking a non-standard, process optimized solution that is tailored to the requirements of a specific machine.

ROPEX can draw on extensive engineering know-how in the area of customized tools –

from the initial feasibility study through the development of the heating element and the design of the cooling body to the manufacture and delivery of a fully functional end product. The temperature distribution on the finished heating element is documented in the form of an IR thermal image. Our broad experience base guarantees an efficient solution that is optimally adapted to the problem at hand.



Samples

- Shaped tools
- Multiple tools
- Blister tools
- Heatsealing elements with an additional sensor layer (process monitoring, validation)
- Tools with temperature profiles

7. Opposing UPT heatsealing tools: silicone profiles and silicone retainers

In contrast with conventional heatsealing band technology, where the sealing process is determined by the mechanical profile of the band (tapered band, beaded band, T-profile band, round wire etc.), ULTRA-PULSE technology makes use of the cross-sectional geometry of the silicone profile on the opposite side. The heatsealing tool is not modified.

Flat or trim seals with specific properties can be created by combining different cross-sectional geometries of the silicone profile with different elastomer hardnesses, facilitating optimum adaptation to the requirements of the process.

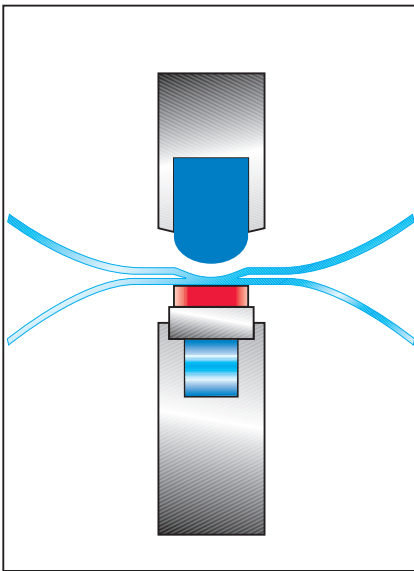

Flat seal

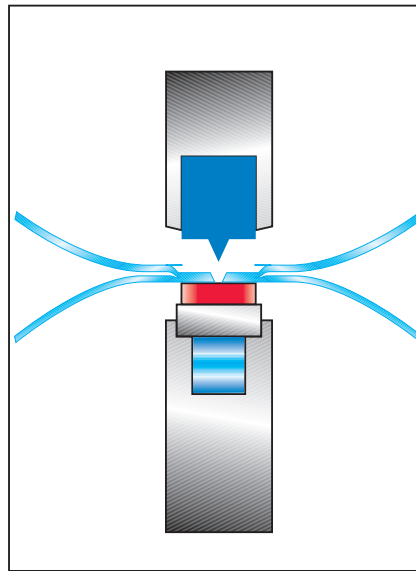

Trim seal with wide sealing zone

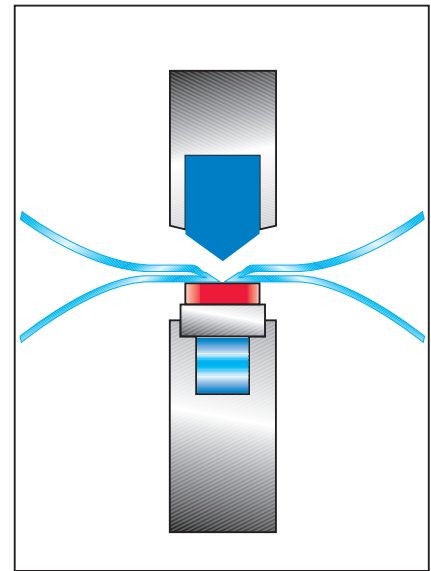

Trim seal with narrow sealing zone

In order to ensure that these processes are absolutely reliable, ROPEX offers precision silicone profiles made by injection molding. Unlike extrusion, this production method guarantees precise, uniform cross-sectional geometries and the necessary high temperature resistance.

The wide range of possible profile dimensions and geometries enables an efficient solution to be found for almost any task (refer to our "Silicone profiles" leaflet).

Machined aluminum bars in the corresponding standard lengths are available for mounting the silicone profiles (refer to our "UPT standard heatsealing bars" leaflet).

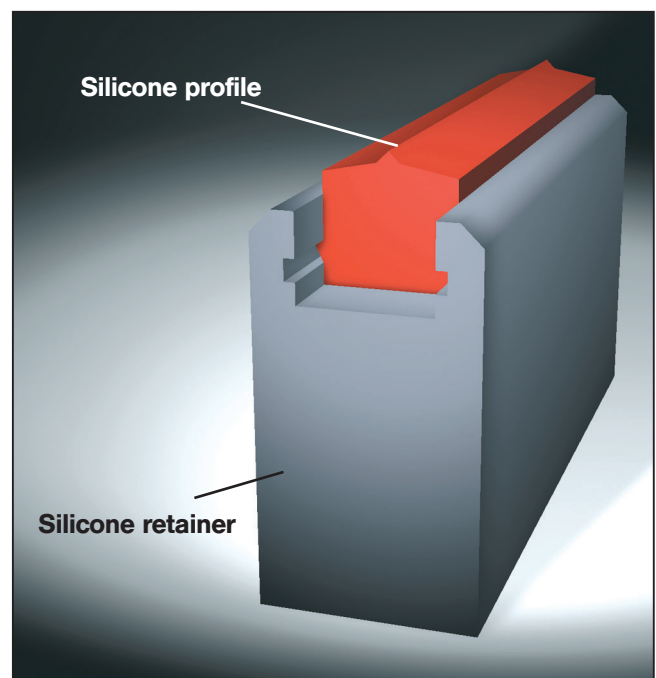

8. Film release after the heatsealing process

The adhesion on an ULTRA-PULSE tool following the heatsealing process varies considerably from one film to another.

Some types of film hardly adhere at all to the tool surface and can therefore be released without any external assistance. Other films exhibit a slight-to-moderate tendency to stick. Since the strength of the heatseal is restored immediately after the sealing

process it is sufficient to apply a tensile force to these films in order to detach them from the tool surface. For example by opening the tool with the film still clamped inside it or simply through the weight of the packaged product.

If the film adheres strongly, it can be released from the tool subsequently by applying a short heat impulse.

Film release with a heat impulse (release impulse)

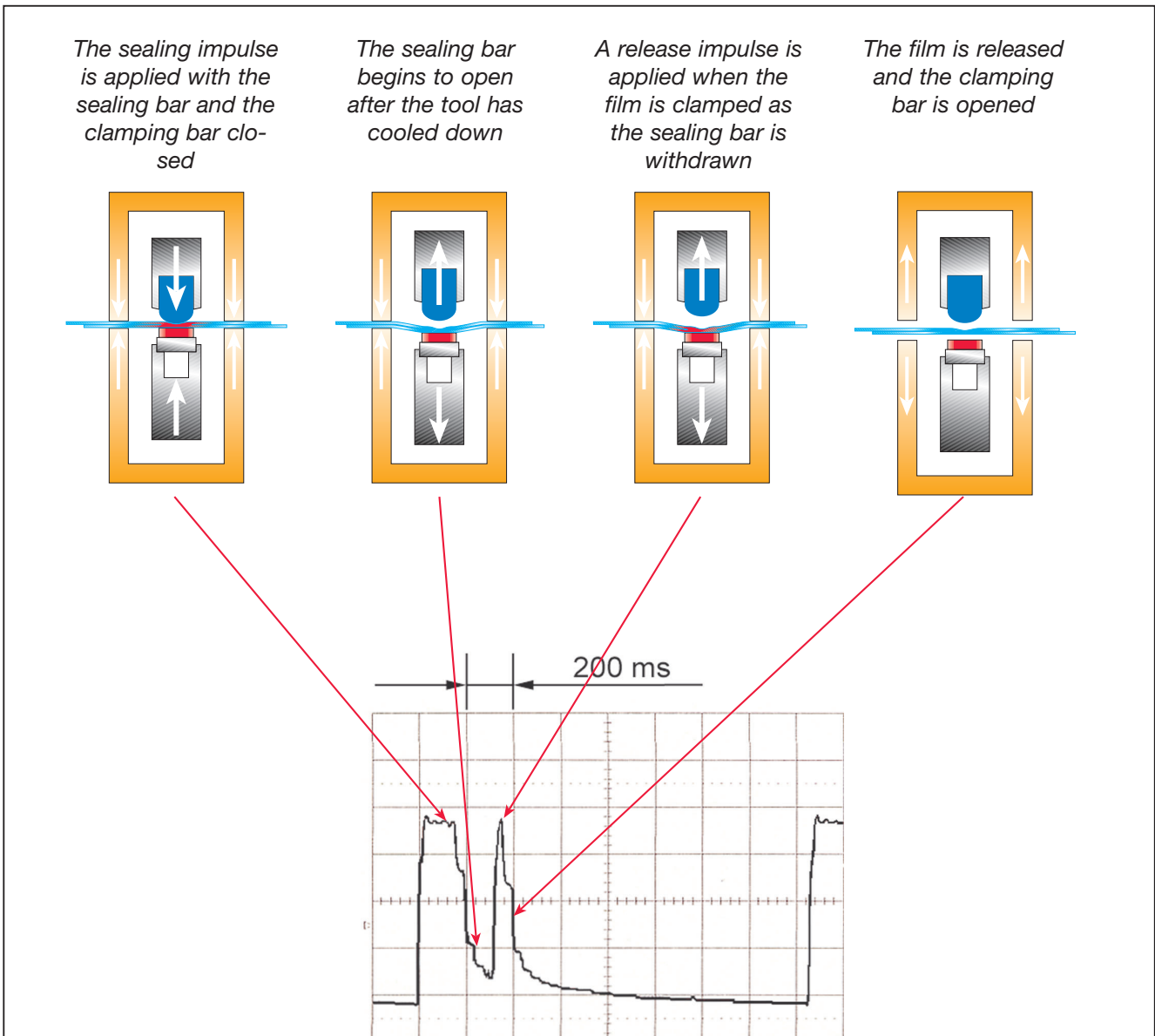

The use of a classic Teflon glass fiber material for the anti-stick cover has also proved successful with UPT heatsealing tools.

In addition to good anti-stick properties and easy replacement, this material also effectively protects the glass ceramic surface of the heating element against friction, abrasion, scoring, or other mechanical damage from the film or the product being packed.

Compared to conventional heatsealing band technology, the ULTRA-PULSE tool significantly increases the life of the Teflon cover because the edge zones are never overheated.

The material should be as thin as possible because the anti-stick layer also reduces the thermal dynamics of the system.

Teflon glass fiber bands with a suitable thickness and width as well as a non-adhesive middle zone can be supplied by ROPEX.

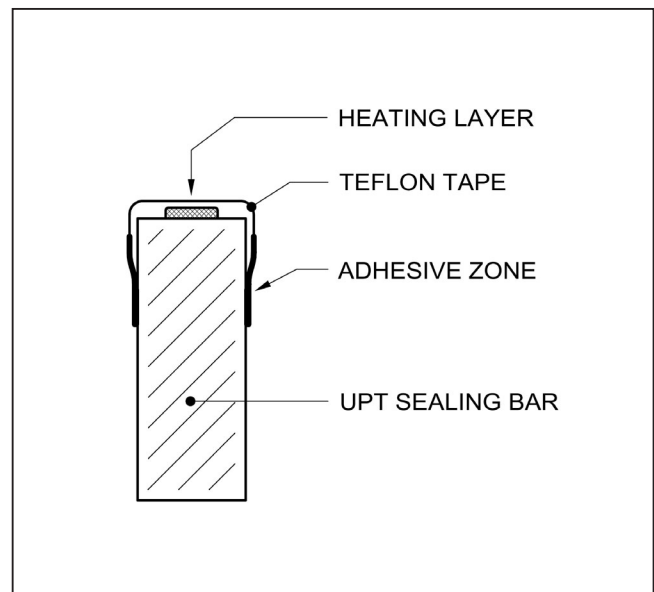

For more information, refer to the "Accessories" section of our "UPT standard heatsealing bars" leaflet.

9. Electrical components

All electrical components required to operate CIRUS heating elements can be supplied by ROPEX.

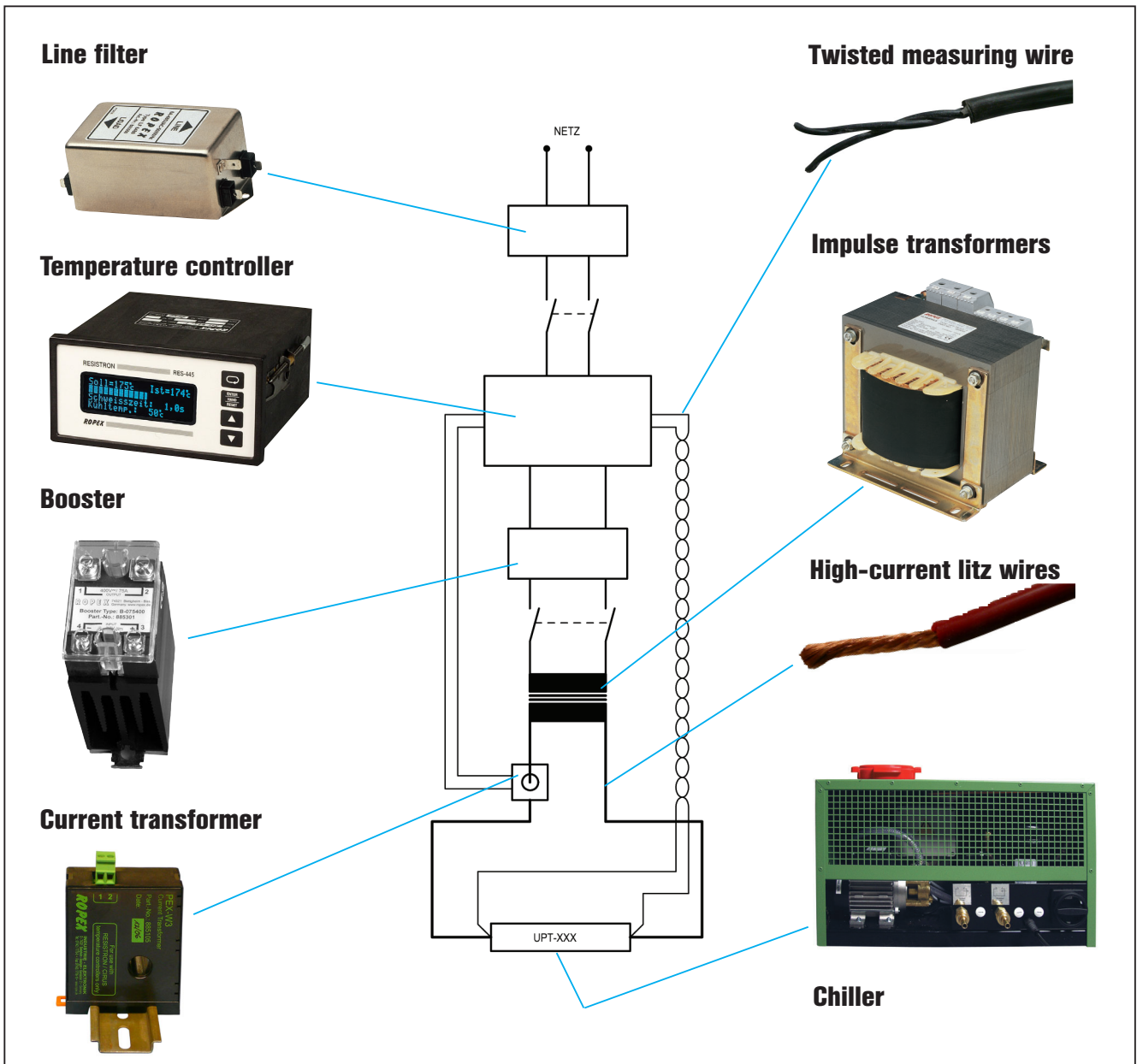

These components and all relevant control loop data are optimally adapted by ROPEX to each application and documented in a circuit diagram.

This ensures efficient interaction between all functional elements for the given task and

enables the enormous potential created by this innovative technology to be fully leveraged.

10. Temperature controllers

The extreme thermodynamics of heating elements designed with CIRUS technology demand temperature controllers that are specially optimized for this kind of system.

ROPEX series "600" temperature controllers guarantee full compliance with all requirements and facilitate precise temperature control.



The impressive functionality of these controllers, including:

- Indication in real time
- Autocal

- Time base for heating and cooling times
- Fault diagnosis
- Temperature OK signal
- Cooling circuit monitoring
- etc.

in combination with a brilliant VFD display and simple, intuitive operation assures maximum reproducibility, stability, and transparency of the heatsealing process.

OVERVIEW OF TYPES Series "600" temperature controllers for CIRUS heating elements

SERIE „600“	TYPE OF CONTROLLER	TYPE OF CONSTRUCTION	FOR SEALING ELEMENT TYPE	AUTOCAL	TEMPERATURE SETTING AND INDICATION	SEALING AND COOLING TIME	RELEASE IMPULSE	PREHEATING	BOOSTER OUTPUT	MEAS. INPUT FOR TEMP.SENSOR
UPT-640		ULTRA-PULSE	Via menu or external control signal (24VDC)	Via Menu or external analog signal (0-10VDC)	●	●	—	●	—	
LPT-640		LONG-PULSE			●	—	●	●	●	
UPT-606		ULTRA-PULSE	via PROFI-Bus			—	—	●	—	
LPT-606		LONG-PULSE				●	●	●		

Data subject to change 06/07

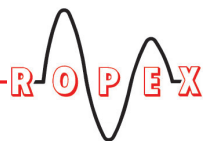









Agents in:

INDUSTRIE-ELEKTRONIK













- Denmark / Scandinavia
- Italy / Switzerland
- U.S.A. / Canada
- Mexiko / South America
- South Africa

SF-xxx Silicone profiles

®

Silicone profiles for flat seam										
Shape	Profile no.	Width [mm]	Length [mm]	Hardn. [Shore]	Surface	Article description	Article number	Color	Associated retainer	Remark
	01	4	470	40	glazed	SF-F01-04-470-40	651015	red	SH-XXX/4	Flat seam profile, narrow
				60		SF-F01-04-470-60	651016	blue		
				80		SF-F01-04-470-80	651017	black		
	04	6	630	40	structured	SF-F04-06-630-40	651045	red	SH-XXX/6	Flat seam profile, semi wide
				60		SF-F04-06-630-60	651046	blue		
				80		SF-F04-06-630-80	651047	transp.		
	10	9	470	40	structured	SF-F10-09-470-40	651067	red	SH-XXX/9	Flat seam profile, semi wide
				60		SF-F10-09-470-60	651066	blue		
				40		SF-F11-09-470-40	651086	red		
	09	12	470	60	structured	SF-F11-09-470-60	651087	blue	SH-XXX/12	Flat seam profile, wide
				40		SF-F09-12-470-40	651062	red		
				60		SF-F09-12-470-60	651063	blue		
	13	6	Sold by meter	40	glazed	SF-F17-12-470-40	651088	red	SH-XXX/4-01	T-Profile, narrow
				60		SF-F17-12-470-60	651089	blue		
	12	8	Sold by meter	40	glazed	SP-F13-4/6-40	651079	transp.	SH-XXX/4-01	T-Profile, wide
				60		SP-F13-4/6-60	651080	transp.		
	20	9	Sold by meter	---	structured	SP-F12-4/8-40	651077	transp.	---	Silicone foam, self adhesive
				60		SP-F12-4/8-60	651078	transp.		
	21	9	Sold by meter	---	structured	SS-F20-9/3-SK	651081		---	Silicone foam, self adhesive
						SS-F21-9/4,5-SK	651082		---	Silicone foam, self adhesive

11.10.10

Silicone profile for cut-and-seal										
Shape	Profile no.	Width [mm]	Length [mm]	Hardn. [Shore]	Surface	Article description	Article number	Color	Associated retainer	Remark
	02	4	470	80	glazed	SF-T02-04-470-80-HT	651069	black	SH-XXX/4	Trim wedge, narrow
	05	6	630	80	structured	SF-T05-06-630-80	651053	black	SH-XXX/6	Trim seal, narrow
					glazed	SF-T16-06-630-80	651091	black		
	06	6	630	80	glazed	SF-SF-T06-06-630-80	651059	black	SH-XXX/6	Trim wedge, wide
	15	9	470	80	glazed	SF-T15-09-470-80	651074	black	SH-XXX/9	Trim seal, semi wide
	08	12	470	80	structured	SF-T08-12-470-80-HT	651072	black	SH-XXX/12	Trim seal, wide
					glazed	SF-T18-12-470-80	651090	black		
	11	4/12	470	40 60	structured	SF-T11-04-470-40	651065	black	SH-XXX/12	Twin-Shore, 2xT11, 1x T02
					glazed	SF-T11-04-470-60	651068	blue		
	14	12	620	80	glazed	SF-T14-12-620-80-HT	651075	black	SH-XXX/12-01	Trim seal, „extra long“
			1240			SF-T14-12-1240-80-HT	651073	black		
	R01	Diam. 8mm	Sold by meter	40 60	glazed	SP-R01-8-40 SP-R01-8-60	101099 101100	transp. transp.	---	Round profile, with T14 also